



PRODUCT CATALOGUE



ABOUT US

As a leading European manufacturer and trader of branded household and away-from-home hygiene paper products, the history of our group dates back to 1999, when we founded **Vajda-Papír Ltd.** as a family business. Now, **Vajda-Papír** employing around 650 people across our group of three Hungarian and one Norwegian plants.

Over the last two decades, **Vajda-Papír group** has become a market player with significant results also on the international scene due to a conscious strategy. In addition to sales in Hungary and Norway, the company's tissue paper products are shipped to more than 30 countries worldwide, and more than 50% of the Group's total tissue paper production is sold in export markets. In 2022 **Vajda-Papír** doubled its turnover at both its Hungarian and Norwegian subsidiaries, with a total turnover of more than 207 million EUR. The group's annual paper production is expected to exceed 150 thousand tonnes in 2023.

We are growing in a sustainable and dynamic way. Sustainability, green solutions and circular economy are important elements of our Group's vision. Therefore, we pay special attention to the innovative, efficient and sustainable operation, to the environmentally friendly production starting from product development through manufacturing and transport to sales. We strive to minimise our impact on the environment in all our activities:

- we produce our tissue paper from raw materials sourced from FSC® certified responsibly managed forests and other controlled sources.
- in paper production, 100% of material from chipping, edge trims and cut-offs which generated during processing are pulped again and recycled.
- with sustainable water and wastewater management gives us a proper biological treatment of water from paper production, which also increasing energy efficiency.
- our production technologies and processes adapted to the circular waste management system therefore our product packaging is 100% recyclable and contains 60% recycled material.

Even though **Vajda-Papír** is mainly known as household paper producer, in 2018 we have launched our new away-from-home division to target a new customer segment, the industrial market and present the **Oops! Professional** branded range, which contains high quality hygiene paper products specifically developed for HoReCa utilization.

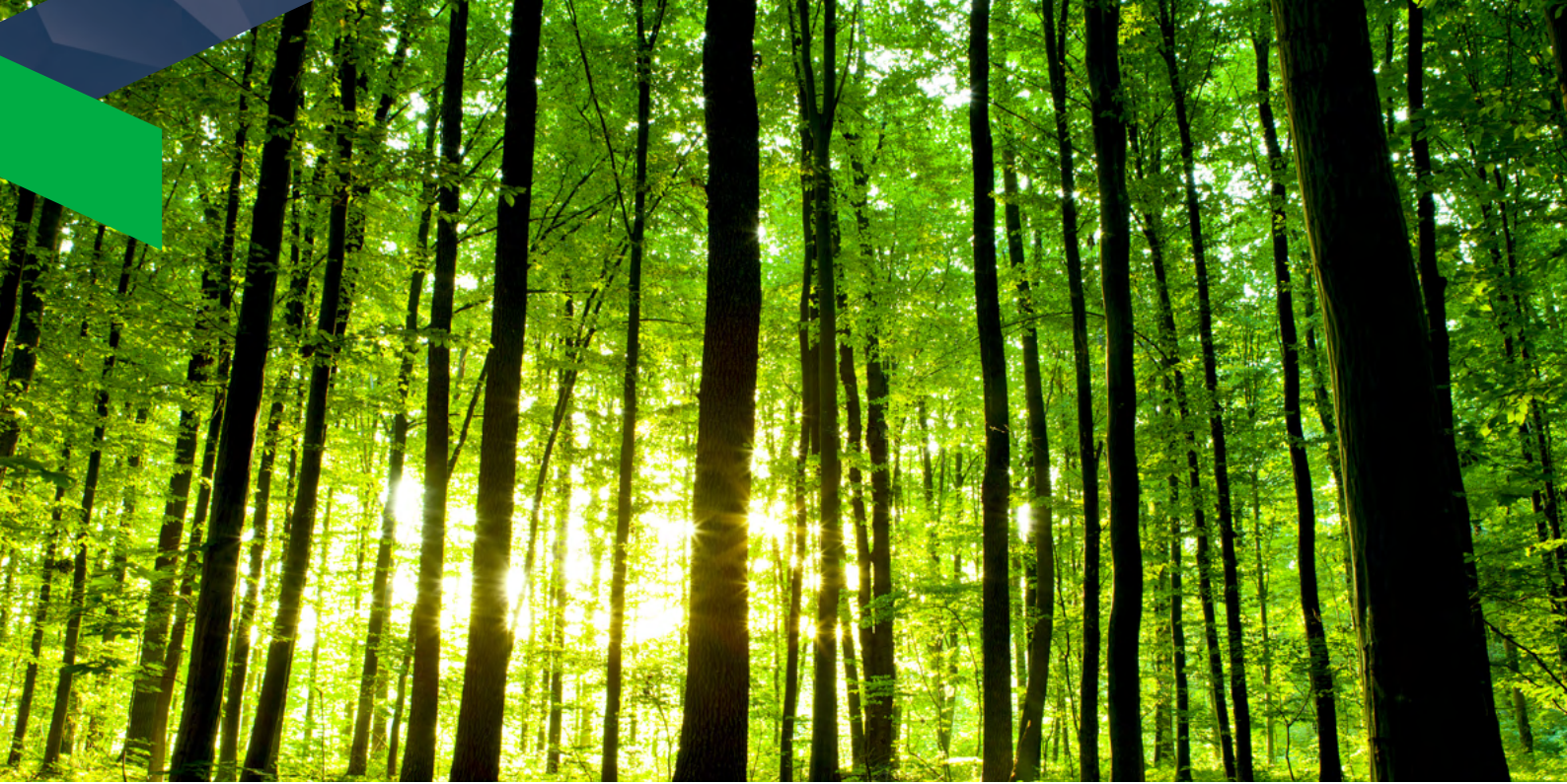

SUSTAINABILITY

Using environmentally friendly solutions is one of the main principles of **Vajda-Papír**. Therefore, it is a main purpose for us to create a working environment in the most innovative way. In addition, our company follows and abides by the rules and regulations governing our activities, but we go beyond that by performing activities the environmental impact of which meets the strictest standards. We keep developing and training our staff; to take their professional skills into consideration when making decisions.

At **Vajda-Papír** we believe that production should also be environmentally friendly, so by making useful products at a competitive price, in a way that is both economical and have minimal environmental impact, using the latest advances in technology and logistics. Reusing production waste is also a high priority, e.g. during the production all base paper waste is being reused.

CERTIFICATES

We are proud of having



The mark of responsible forestry



WASHROOM



WORKPLACE



HEALTH & SAFETY



TABLE TOP



SYSTEMS



TOILET PAPERS



Ooops! Professional (KTC20012048)

Mini Jumbo Toilet paper, 2 ply cell. 19 cm, 500 sheets



2 ply		12
9 x 20 cm	190 mm	60 mm
500	100 m	5998648708783



Ooops! Professional (KTC20011699)

Mini Jumbo Toilet paper 2 ply, cell., 19 cm, 680 sheets
Dispenser: AE57000



2 ply		12
9.15 x 20 cm	190 mm	60 mm
680	136 m	5998648701043



Ooops! Professional (KTC20121763)

Mini Jumbo Toilet paper 2 ply, cell., 19 cm, 750 sheets
Dispenser: AE57000



2 ply		12
9.15 x 20 cm	190 mm	60 mm
750	150 m	5998648706628



Ooops! Professional (KTC20012047)

Mini Jumbo Toilet paper, 2 ply cell. 19 cm, 850 sheets



2 ply		12
9 x 20 cm	190 mm	60 mm
850	170 m	5998648708776



TOILET PAPERS



Ooops! Professional (KTC20012123)

Mini Jumbo Toilet paper, 2 ply cell. 15 cm, 526 sheets, centerfeed



2 ply		12
13,5 x 19 cm	150 mm	
526	100 m	5998648709230



Ooops! Professional (KTC20062071)

Mini Jumbo Toilet paper, 2 ply cell. 19 cm, 895 sheets, centerfeed



2 ply		6
13,5 x 19 cm	190 mm	
895	170,05 m	5998648708882



Ooops! Professional (KTC20011541)

Midi Jumbo Toilet paper 2 ply, cell., 23 cm, 680 sheets



2 ply		6
9,15 x 20 cm	230 mm	60 mm
680	170 m	5998648705799



Ooops! Professional (KTC20012116)

Maxi Jumbo Toilet paper 2 ply cell. 29 cm, 1535 sheets



2 ply		6
9 x 28 cm	230 mm	60 mm
1535	430 m	5998648709223



TOILET PAPERS



Ooops! Professional (KTC20011684)

Maxi Jumbo Toilet paper 2 ply, cell., 29 cm, 1500 sheets

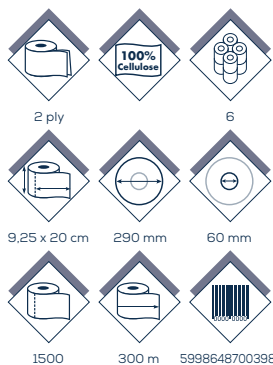

Ooops! Professional (KTC20012049)

Maxi Jumbo Toilet paper 2 ply cell. 26 cm, 1750 sheets

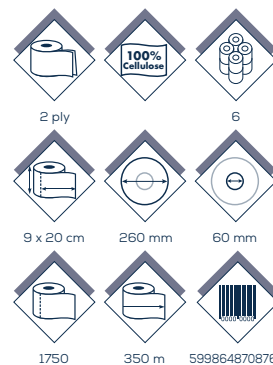

Ooops! Professional (KTC30041351)

Small roll Toilet paper 3 ply, cell., 4 rolls, 150 sheets

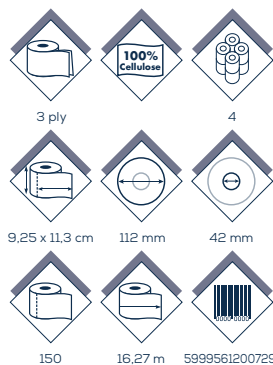

Ooops! Professional (KTC20082103)

Small roll Toilet paper 2 ply, cell., 8 rolls, 200 sheets

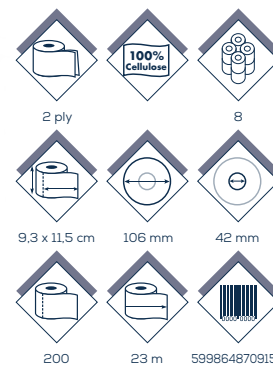

TOILET PAPERS



Ooops! Professional (KTC20081764)

Small roll Toilet paper 2 ply, cell., 8 rolls, 250 sheets

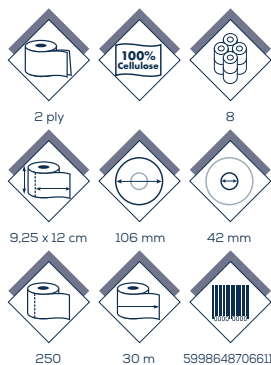

Ooops! Professional (KTC30081392)

Small roll Toilet paper 3 ply, cell., 8 rolls, 250 sheets

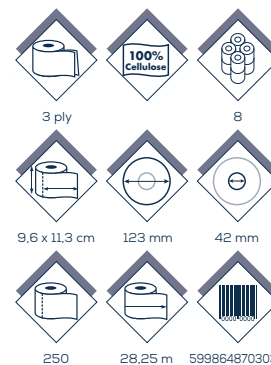

Ooops! Professional (KTC20301685)

Small roll Toilet paper 2 ply, cell., 30 rolls, 500 sheets

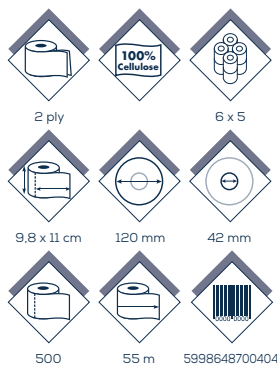

HAND TOWEL ROLLS

Ooops! Professional (KKC10011687)

Mini Rolled hand towel 1 ply, cell., 14 cm, 450 sheets, coreless



Ooops! Professional (KKC10011829)

Mini Rolled hand towel 1 ply, cell., 14 cm, coreless, not perforated



Ooops! Professional (KKC20122104)

Mini Rolled hand towel 2 ply, cell., 14 cm, 260 sheets, coreless



Ooops! Professional (KKC20012051)

Mini Rolled hand towel 2 ply, cell., 14 cm, 50m



HAND TOWEL ROLLS

Ooops! Professional (KKC20011542)

Midi Rolled hand towel 2 ply, cell., 14 cm, 325 sheets, coreless, Dispenser: AG47000

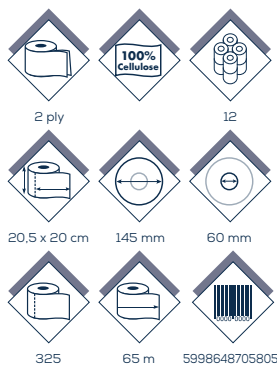

Ooops! Professional (KKC10011688)

Midi Rolled hand towel 1 ply, cell., 20 cm, 1000 sheets, coreless, Dispenser: AG47000

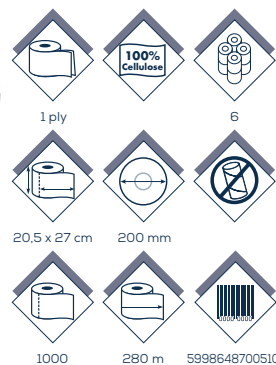

Ooops! Professional (KKC10011830)

Midi Rolled hand towel 1 ply, cell., 20 cm, coreless, not perforated, Dispenser: AG47000

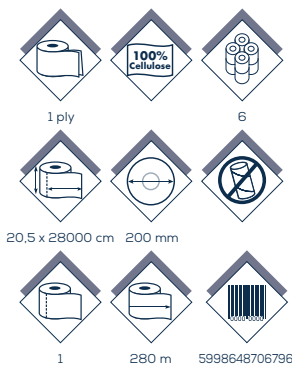

Ooops! Professional (KKC20011543)

Midi Rolled hand towel 2 ply, cell., 20 cm, 500 sheets Dispenser: AG47000



HAND TOWEL ROLLS



Ooops! Professional (KKC20062105)

Autocut Midi 42 hand towel 2 ply, cell, 19 cm, not perforated













		
2 ply		6
		
21 x 13000 cm	190 mm	40 mm
		
1	130 m	5998648709179



Ooops! Professional (KKC20012062)

Autocut Midi 46 hand towel 2 ply, cell, not perforated











		
2 ply		6
		
20 x 13000 cm	200 mm	40 mm
		
1	130 m	5998648708868



Ooops! Professional (KKC20012063)

Autocut Midi 42 hand towel 2 ply, cell, not perforated



		
2 ply		6
		
20 x 15000 cm	200 mm	40 mm
		
1	150 m	5998648708851

FOLDED TOWELS & DISPENSER NAPKIN

Ooops! Professional (KKC22002102)

Z fold hand towel 2 ply. cell., 21 x 21 cm, 200 sheets
Dispenser: AH37000

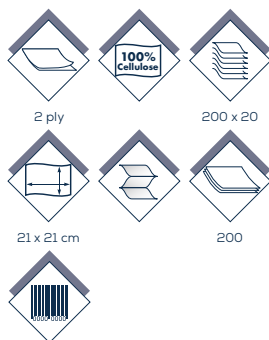
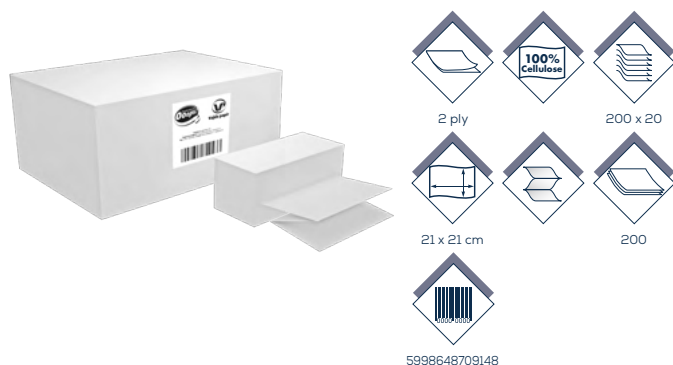

5998648709148



Ooops! Professional (KKC21501493)

V fold hand towel, 2 ply. cell., 25 X 21 cm, 150 sheets
Dispenser: AH37000

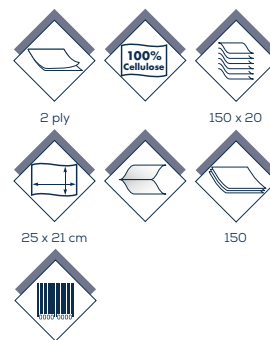
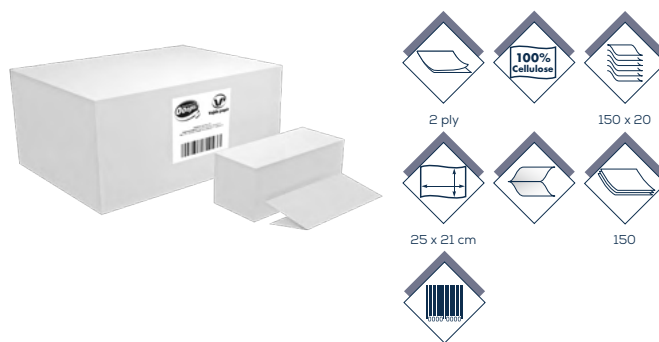

5999833645611



Ooops! Professional (KSC22001696)

Dispenser napkin 2 ply, 21x16,5 cm, 160 sheets, white,
Non Stop

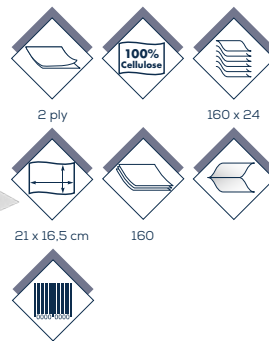
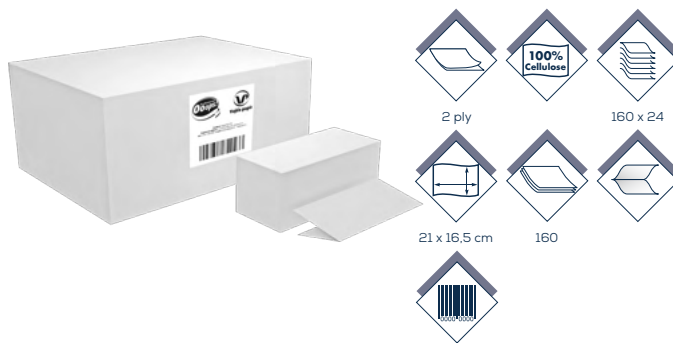

5998648706123

INDUSTRIAL ROLLS

Ooops! Professional (KKC10011692)

Industrial roll 1 ply, cell., white, 30 cm, non perforated,
Dispenser: AD10000

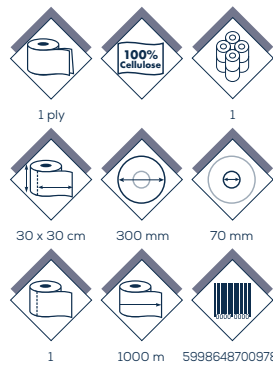

Ooops! Professional (KKC20011544)

Industrial roll 2 ply, cell., white, 20 cm,
Dispenser: AD10000

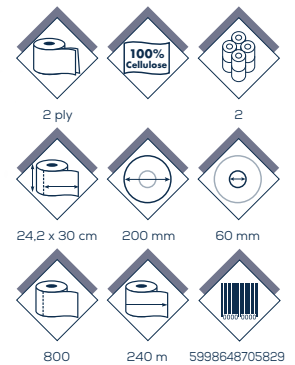

Ooops! Professional (KKC20011545)

Industrial roll 2 ply, cell., white 29 cm,
Dispenser: AD10000

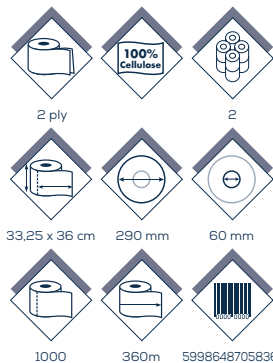

Ooops! Professional (KKC20011693)

Industrial roll 2 ply, cell., white, 30 cm,
Dispenser: AD10000

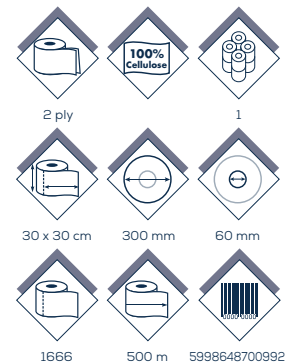

WORKPLACE

INDUSTRIAL ROLLS

Ooops! Professional (KKC10012012)

1 roll, 1 ply, Heavy industrial roll, 800 m
Dispenser: AD10000

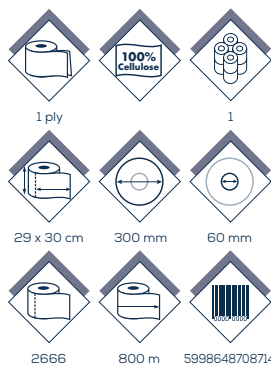

WORKPLACE

INDUSTRIAL ROLLS

Ooops! Professional (KKC20011804)

Farm Heavy-Duty industrial roll 2 ply cell., white, 25,5 cm
Dispenser: AD10000

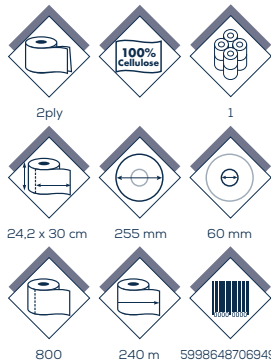

- ✓ Heavy-Duty paper towel
- ✓ Higher fiber content
- ✓ High wet tensile strength
- ✓ 3x more efficient absorbency*
*compared with standard industrial paper towels
- ✓ Clears large amounts of liquid contaminants



applicable in
many industries



MEDICAL ROLLS



Ooops! Professional (KKC20011694)

Medical roll 2 ply, cell., 50 cm, 50 m

2 ply		9
50 x 34 cm	130 mm	60 mm
147	50 m	5998648701012

Ooops! Professional (KKC20011695)

Medical roll 2ply, cell., 60 cm, 50 m

2 ply		9
60 x 34 cm	130 mm	60 mm
147	50 m	5998648701029



HEALTH
& SAFETY

FACE MASKS



Ooops! Professional (KM30241849; KM31001820)

Surgical face mask, 10 pcs Type IIR

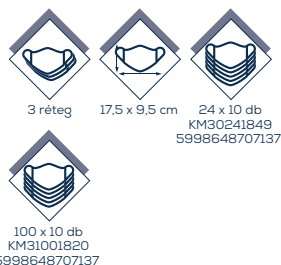

Ooops! Professional (KM30401819)

Surgical face mask, 50 pcs Type IIR



Ooops! Professional (KM30301798; KM30301800)

Face mask 3 ply, 10 pcs

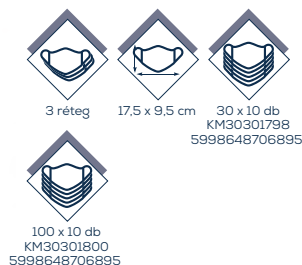

Ooops! Professional (KM30301799)

Face mask 3 ply, 50 pcs



FACE MASKS



Ooops! Professional Surgical face mask 3 ply Type IIR



BFE

Bacterial filtration efficiency is over 98%



Protection

Type IIR



Breathable

Three layers of protection, non-woven fabrics 25 gsm / layer



Comfortable fit

High elastic round ear loop, low pressure, ears more comfortable; better face sealing due to the longer 120 mm length of clip for perfect and comfortable fitting

Medical device

Type IIR

**Applicable standard
EN 14683:2019 + AC:2019**

Made in EU



- ✓ **Medical device**
Detailed technical documentation, authority registration
- ✓ **Regulated, controlled and validated cleanroom**
- ✓ **Comply with EN 14683: 2019 + AC: 2019 standard**
Laboratory report - according to EN 14683, Type IIR classified medical device
- ✓ **Made in Europe, made in Hungary**
- ✓ **CE marking**
EC declaration of conformity - medical device Class I.



Production line:

- ✓ Line: latest state of art technology (made in Europe)
- ✓ 600 masks/minute production capacity
- ✓ 300 million mask / year capacity
- ✓ automated primary and secondary packaging systems

Cleanroom:

- ✓ verified Class ISO 8 level according to ISO 14644-1 standard (classification of air cleanliness)
- ✓ to eliminate the contamination risk
- ✓ to keep the material cleanliness

TABLE TOP

NAPKINS

Ooops! Professional (KSC15001868)

Napkin 1 ply, 24 x 24 cm 500 sheets, white, 1/4 fold

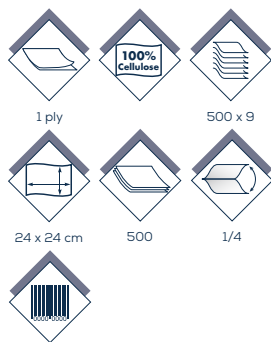

5998648707625

Ooops! Professional (KSC15001869)

Napkin 1 ply, 32 x 32 cm 500 sheets, white, 1/4 fold

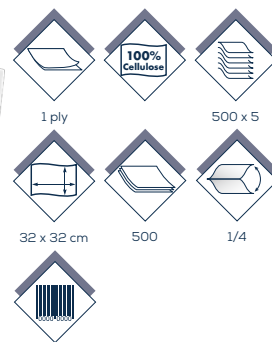

5998648707663

Ooops! Professional (KSC17001700)

Gastro Napkin 1 ply, 32 x 32 cm 700 sheets, white, 1/4 fold, display

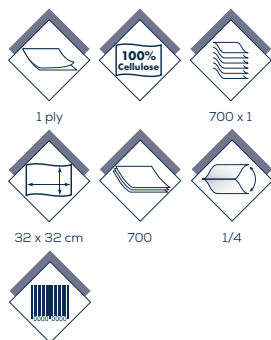

5998648704532

Ooops! Professional (KSC11002053)

Napkin 2 ply, 32 x 32 cm 100 sheets, white, 1/8 fold

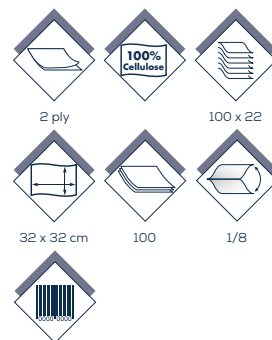

5998648708813



NAPKINS

Ooops! Professional

Napkin 2 ply, 33 x 33 cm 100 sheets, color, 1/4 fold



Ooops! Professional (KSC21001999)

Napkin 2 ply, 33 x 33 cm 100 sheets, white, 1/8 fold

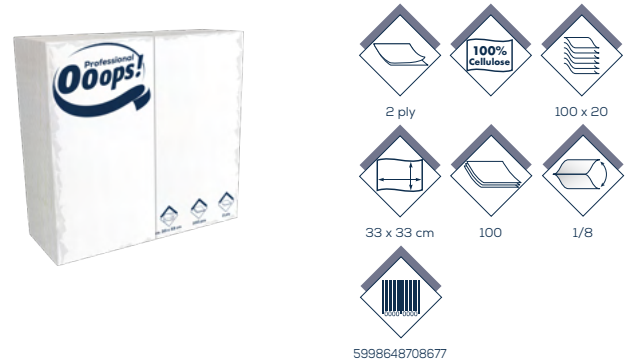

Ooops! Professional (KSC21002001)

Napkin 2 ply, 40 x 40 cm 100 sheets, white, 1/8 fold

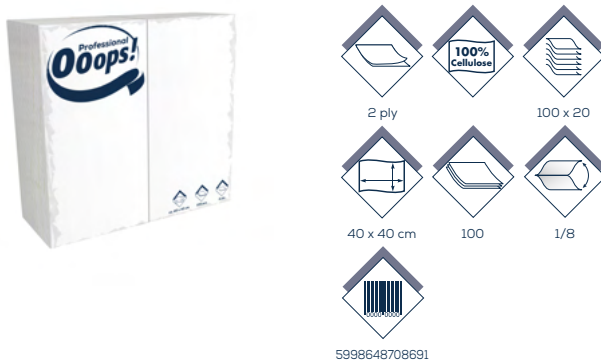

Ooops! Professional

Napkin 2 ply, 40 x 40 cm 100 sheets, white, 1/4 fold

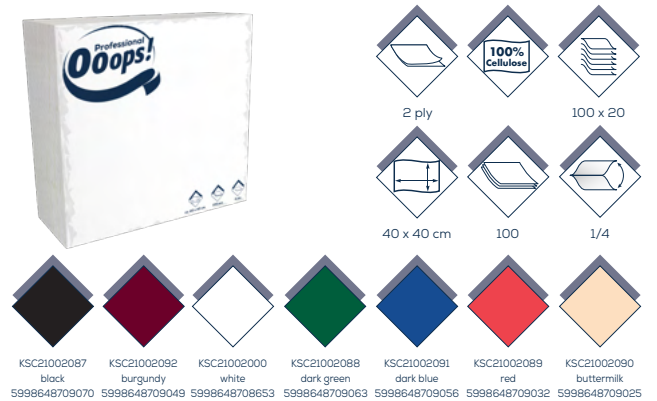
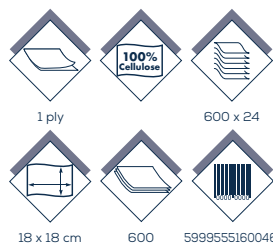

TABLE TOP

NAPKINS

Milyo (KSC16001599)

Napkin 1 ply, 18 x 18 cm, 600 sheets, white



Ooops! Ristorante (KSC16001117)

Napkin 1 ply, 16,5 x 16,5 cm, 600 sheets, white

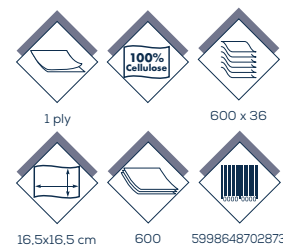

DISPENSERS

AC14000 (KVAD0011891)

EURO BOTTLE REFILL SOAP DISPENSER



- Refill dispensers, made of ABS
- Polyethylene deposit
- Non-drip and anti-corrosion valve
- Key lock (key provided)
- Lever made of inox steel
- Supplied with refillable bottle (empty)
- Content entirely visible
- Max. capacity 1000 ml
- 8427950327476

AC27050 (KVAD0011892)

"SMART" REFILL SOAP DISPENSER



- White ABS Push Button
- Refill ABS dispensers
- Key lock (key provided)
- Content viewer
- Push button integrated on cover
- Polyethylene deposit
- "Low Cost" range of products
- Max. capacity 1000 ml
- 8427950352188

AC70000 (KVAD0011831)

"AITANA" REFILL SOAP DISPENSER



- White ABS Push Button
- Refill dispensers made of ABS
- Non-drip and anti-corrosion valve
- Key lock (key provided)
- Content entirely visible
- Push button integrated in cover
- Transparent deposit made of SAN
- Max. capacity 900 ml
- 8427950300516

AD10000 (KVAD0011832)

INDUSTRIAL ROLL DISPENSER, WALL



- Entirely metallic
- Frame made of steel tube with diameter of 20 mm
- Serrated metal cutter, 1 mm thick
- Rolls up to 500 m
- Roll core of Ø 60/70 mm.
- Polyester electrostatic paint.
- Max. diameter 480 mm
- 8427950300554

DISPENSERS

AE57000 (KVAD0011805)

"SMART" ABS JUMBO TOILET ROLL DISPENSERS



- White ABS
- Toilet tissue dispensers, made of ABS
- Key lock, content viewer
- "Low Cost" range of products
- Reclining front cover
- Length/Max roll core Ø:
300 m/ Ø220 mm/ Ø45 mm
- Max. diameter 220 mm
- 8427950340086

AG17550 (KVAD0011893)

"AZUR" SENSOR ROLL TOWEL DISPENSERS



- White ABS
- Towel roll dispensers
- Activates by approaching hands
- Suitable for power or batteries
- Savings and hygiene: use/touch
- Key lock
- Reclining cover with content viewer
- Max roll/Core Ø: Ø 220 mm/ 40 mm
- Max. diameter 220 mm
- 8427950342769

AG47000 (KVAD0011806)

"SMART" CENTREFEED DISPENSER



- White ABS
- Centrefeed towel roll dispensers
- Key lock
- Reclining front cover with content viewer
- Roll delivered by base/centre
- For rolls up to Ø 200 mm, without core, non-perforated
- "Low Cost" range of products
- Max roll/Core Ø: Ø 205 mm
- Max. diameter 205 mm
- 8427950340109

AG56000 (KVAD0011894)

"AZUR" AUTOCUT DISPENSER



- White ABS
- Dispenses precut towels, 27 cm long
- Requires special perforated paper
- Manual operation of paper, exclusively
- Maximum hygiene: use/touch
- Prevents cross-contamination
- Internal cutter made of mild steel
- Security side wheel
- Key lock
- Reclining front cover, content viewer
- Maximum diameter of roll: 210 mm
- Roll: 210 mm maximum – 191 mm minimum
- Reduced cost, paper saving
- Core: 36 Ø minimum, 45 mm maximum
- Easy and quick to refill
- Latest technology in paper dispensers
- For places with high traffic of people
- Max. diameter 210 mm
- 8427950347511

DISPENSERS

AH37000 (KVAD0011807)

"SMART" "Z" FOLD TOWEL DISPENSERS



- White ABS
- Z-fold towel dispensers
- Key lock
- Reclining cover
- Hygienic: prevents cross contamination
- Content viewer
- For places with high traffic of people
- Capacity: 600 sheets
- 8427950340093

AH60000 (KVAD0061896)

"AZUR/FUTURA" FACIAL TISSUES DISPENSER



- Wall/table top facial tissues dispensers
- Detachable casing
- Tissues delivered by upper opening
- Designed for standard packages
- Luxurious and ornamental
- (FUTURA) Stainless Steel, bright of satin finish
- (AZUR) White ABS or Chromed, Blue or Smoked SAN. Can be customized
- Capacity: 1 Facial tissue box (100 sheets)
- 8427950302992

AH53000 (KVAD0121895)

NAPKIN DISPENSER WHITE, DARK BLUE, BLACK



- Cover, case and base made ABS
- Cover with hinges at both sides
- "Clip" closing system.
- Equipped with spring to adjust napkins gradually.
- Two sides for advertising, made of transparent SAN.
- Four non-slip rubber pads.
- Capacity : 200 pcs z-fold or v-fold napkins, 17x10 cm (closed).
- Napkins dispensed by central longitudinal opening at cover.
- White: AH53000B, Black: AH53000N, Blue: AH53000Z
- 8427950306957

SYMBOLS

	Ply
	Sheets per roll
	Sheets
	Paper quality
	Roll diameter
	Core diameter
	Capacity per pack
	Sheet size
	Roll height, sheet length
	Roll length
	Fold (V, M, Z)
	Fold (1/4, 1/8)
	Rolls per pack
	Coreless
	Centerfeed
	Product ean code



Contact us

professional@vajdapapir.com

<https://vajdapapir.hu/en>

